

1

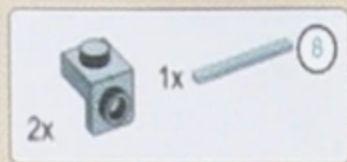

2

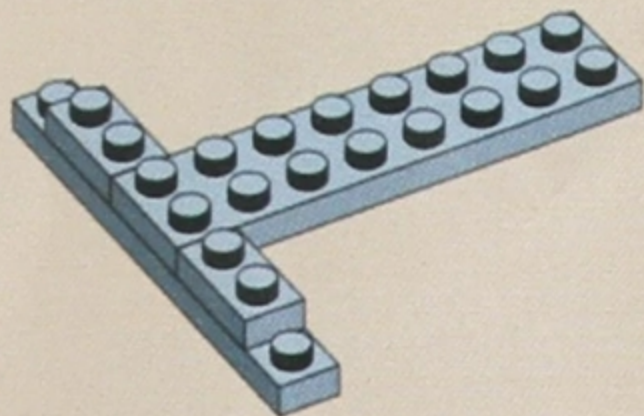
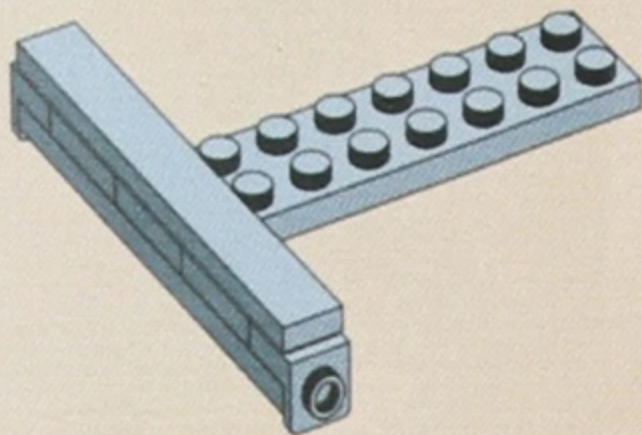

1x



3x



3

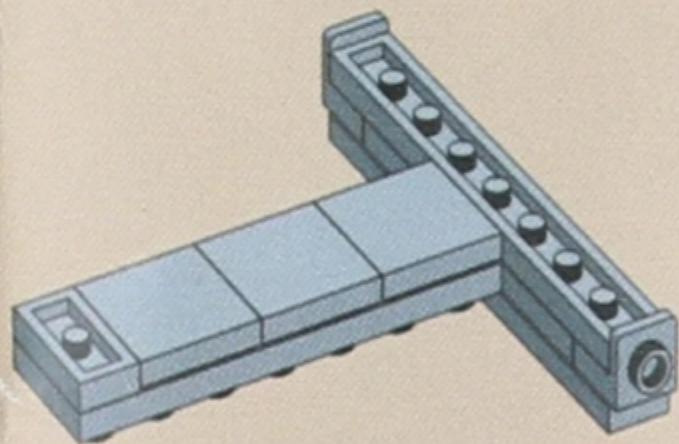

2x



1x



4

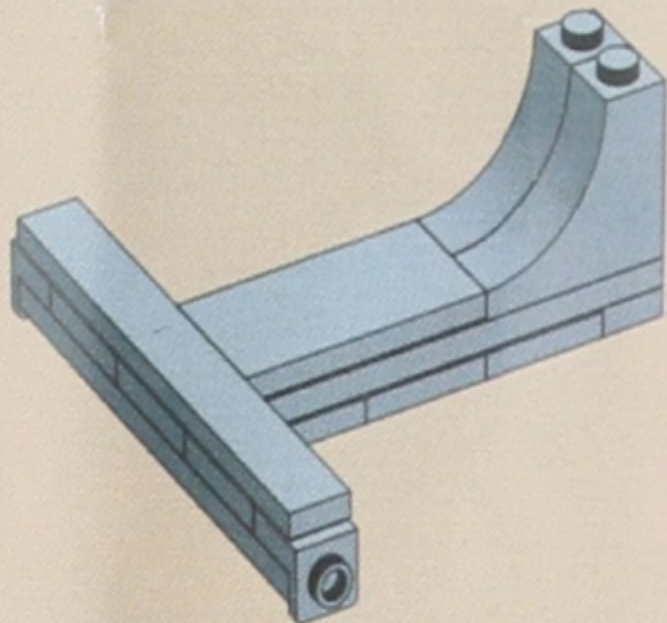
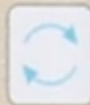



5

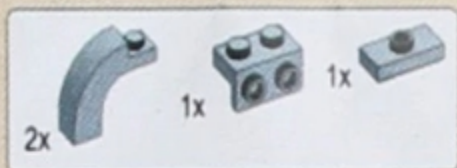
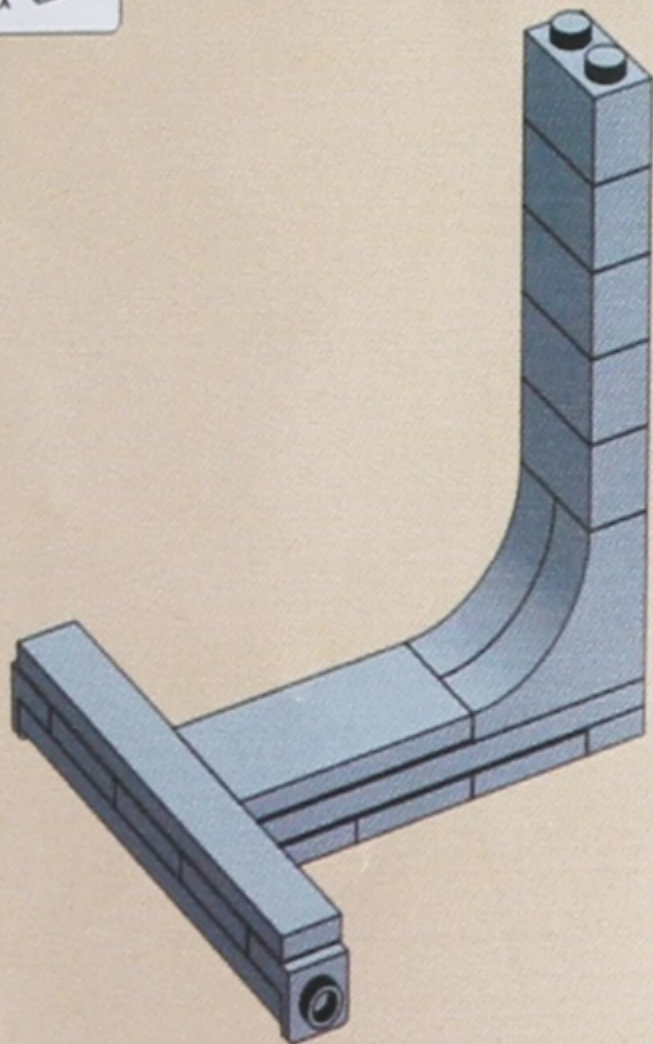

6

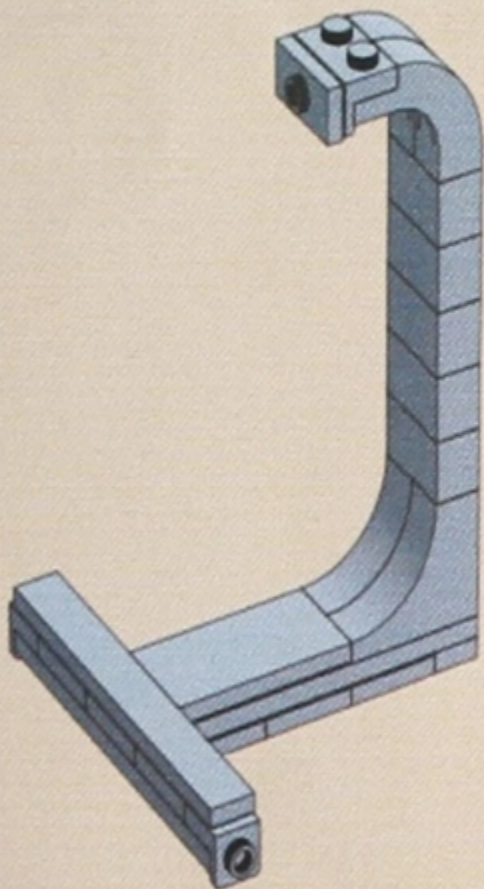



1x



4x



7

2x



1x



2x



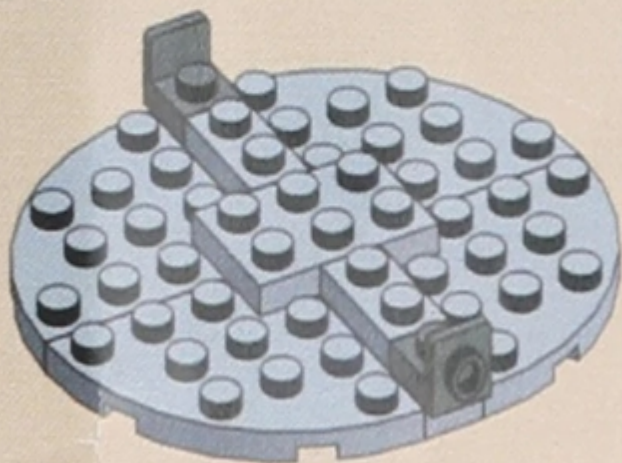
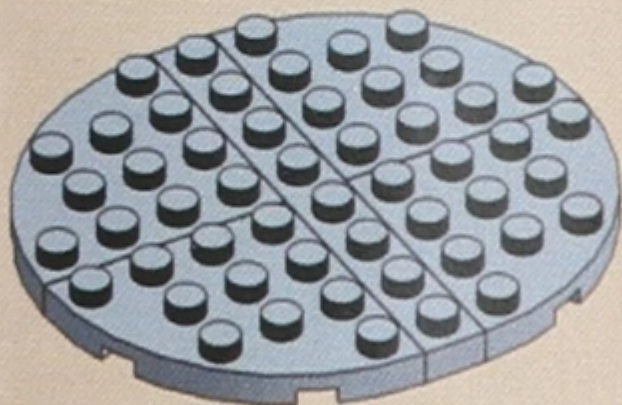

8

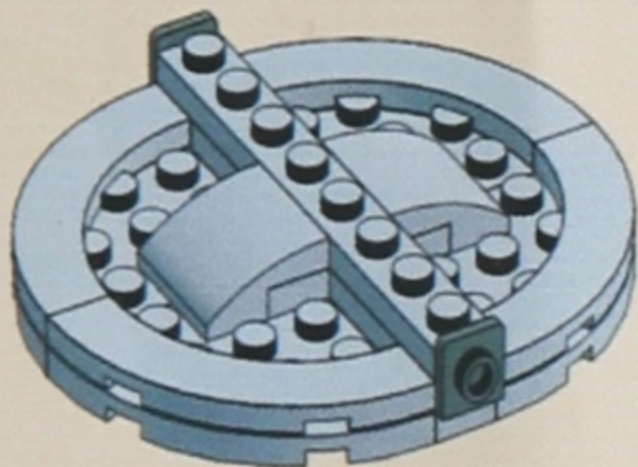

1x  2x  4x 

9



2x  2x 

10

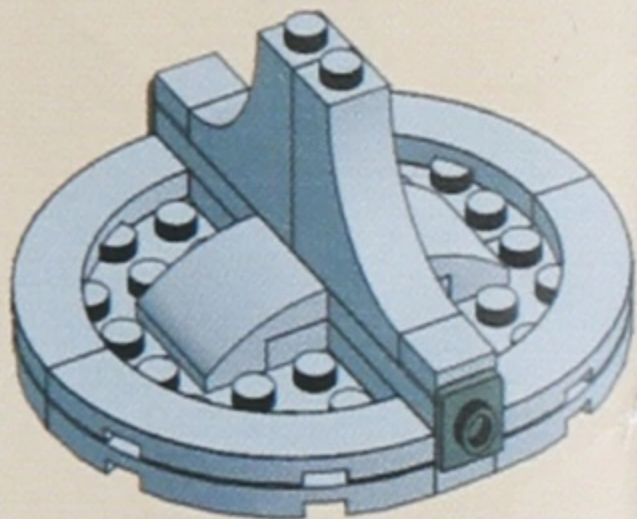



11

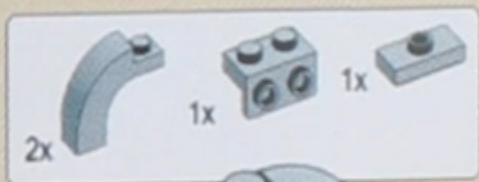
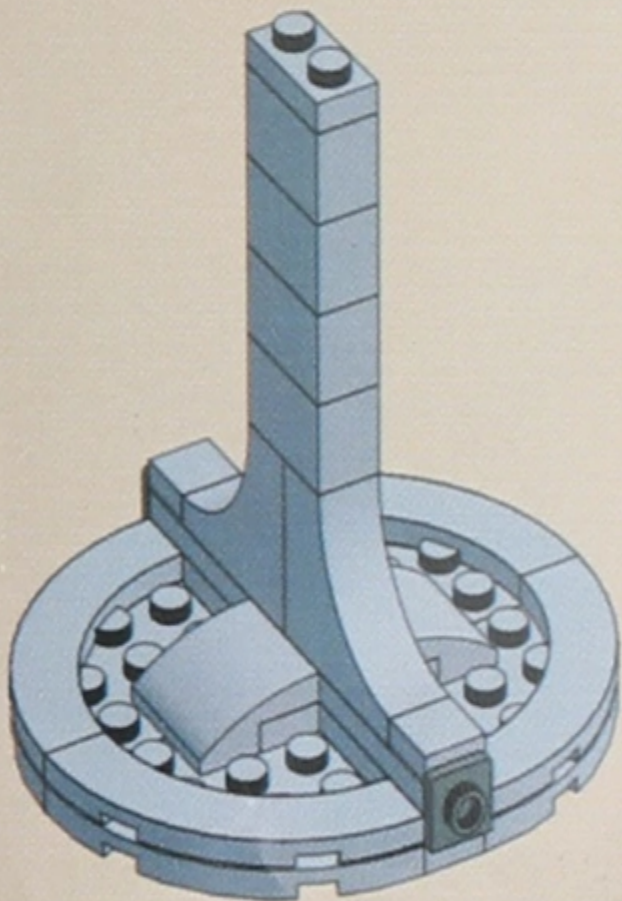

12

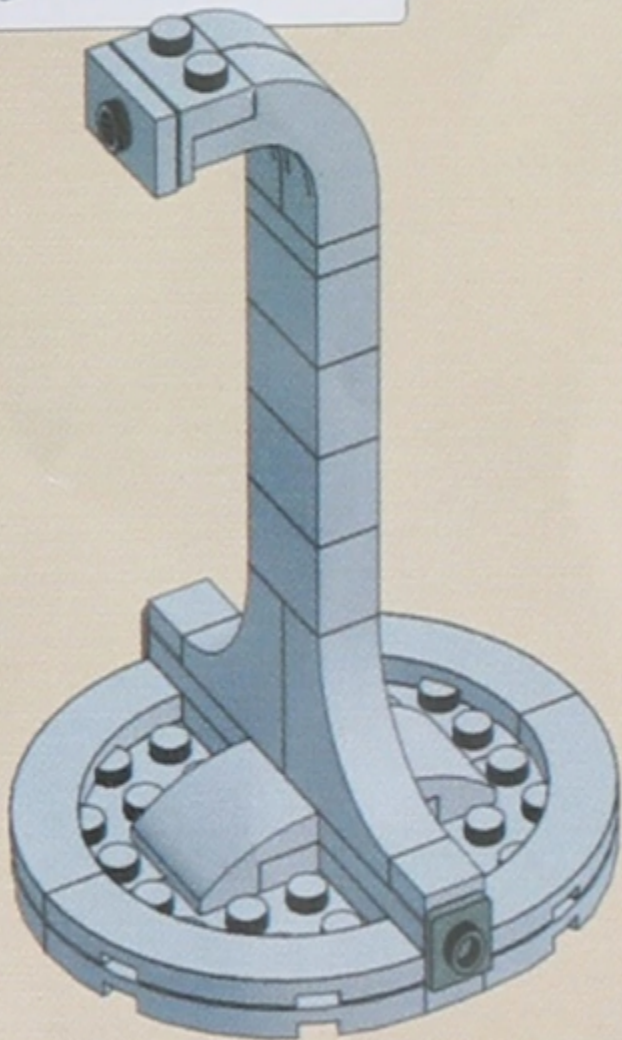

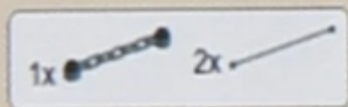

13

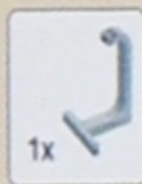
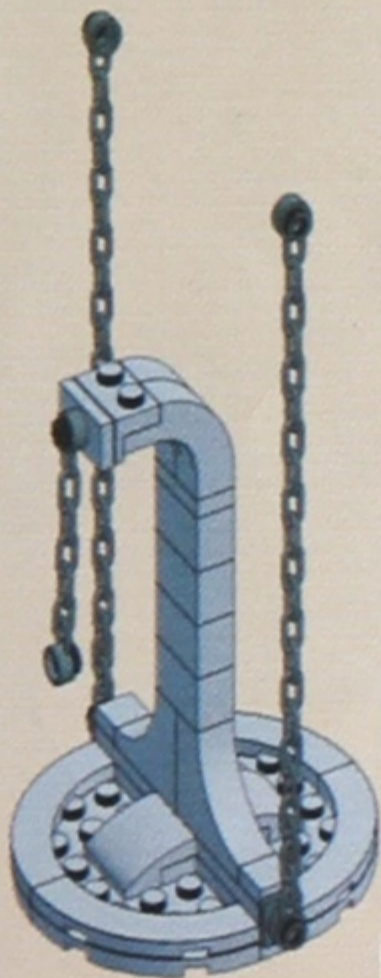

14

